

---

# VPFlowScope In-line

User manual

© 2023 Van Putten Instruments BV



# VPFlowScope In-line

© 2023 Van Putten Instruments BV

All rights reserved. No parts of this document may be reproduced in any form or by any means - graphic, electronic, or mechanical, including photocopying, recording, taping, or information storage and retrieval systems - without the written permission of the publisher.

Products that are referred to in this document may be either trademarks and/or registered trademarks of the respective owners. The publisher and the author make no claim to these trademarks.

While every precaution has been taken in the preparation of this document, the publisher and the author assume no responsibility for errors or omissions, or for damages resulting from the use of information contained in this document or from the use of programs and source code that may accompany it. In no event shall the publisher and the author be liable for any loss of profit or any other commercial damage caused or alleged to have been caused directly or indirectly by this document.

Last revision date: 21-7-2023 in Delft

## **Publisher**

Van Putten Instruments BV  
Buitenwatersloot 335  
2614 GS Delft  
The Netherlands

---

## Table of Contents

<b>1 Warning - Read this first</b>	<b>5</b>
<b>2 Introduction</b>	<b>6</b>
<b>3 Product overview</b>	<b>7</b>
1 Configuration .....	7
2 VPFlowScope In-line D0 (no display).....	8
3 VPFlowScope In-line D10 & D11 (display version).....	8
4 VPFlowScope In-line D0 with the VPFlowTerminal.....	8
<b>4 Quick start</b>	<b>9</b>
<b>5 Measurement</b>	<b>10</b>
1 Flow .....	10
2 Pressure .....	10
3 Temperature .....	10
4 Totalizer .....	11
<b>6 Mechanical installation</b>	<b>12</b>
1 Piping table .....	12
2 Installation without tubing kit .....	13
3 Installation with tubing kit.....	13
4 Installation instructions .....	14
<b>7 Display</b>	<b>16</b>
1 Display status icons .....	16
2 LCD display .....	16
3 Data Logger .....	17
4 Keypad .....	17
5 Menu .....	18
<b>8 VPStudio software</b>	<b>20</b>
<b>9 Electrical connections</b>	<b>21</b>
1 4 .. 20 mA output .....	21
2 Pulse output .....	24
3 Modbus interface .....	25
4 USB interface .....	29
<b>10 Service</b>	<b>30</b>
1 Software and firmware updates.....	30
2 Calibration interval .....	30

---

3 Service subscriptions .....	30
<b>11 Specifications</b>	<b>31</b>
<b>12 Order information and accessories</b>	<b>32</b>
<b>13 Appendix A - UL</b>	<b>33</b>

# 1 Warning - Read this first

	<p><b>Compressed gasses can be dangerous!</b> Please familiarize yourself with the forces under pressurized conditions. Respect the local guidelines and regulations for working with pressurized equipment.</p>
	<p><b>Gas flow through pipes follows certain physical laws.</b> These physical laws have serious consequences for the installation requirements. Familiarize yourself with the basic physical laws of flow measurement, to make sure that the product is installed correctly. Always make sure that upstream length, downstream length, flow, pressure, temperature and humidity conditions are within specifications.</p>
	<p><b>Precision instruments need maintenance.</b> Check your flow meter regularly and make sure it remains clean. When polluted, gently clean the sensor using demineralized water or cleaning alcohol. <b>Precision instruments need regular re-calibration.</b> To keep your VPFlowScope probe in best shape, it needs recalibration. We advice annual recalibration.</p>
	<p><b>Not intended for fiscal metering or billing.</b> Our flow meters are not certified for fiscal metering. Laws on fiscal metering and billing may vary per country or state.</p>
	<p><b>Do not overestimate the results. VPInstruments does not take any responsibility for the correctness of measurement results under field conditions.</b> The practical measurement uncertainty of a flow meter in the field may vary, depending on how well it is installed, due to the nature of gas flow. The piping table provides guidelines on how to optimize the field accuracy. Our products are not intended to be used as a single means to determine compressor capacity.</p>
	<p><b>Do not open the device.</b> Our instruments are assembled with high precision. Opening this device is dangerous and may destroy the instruments. Warranty is voided when you open the instrument.</p>
	<p><b>Feedback leads to product improvement.</b> Please share your experience with us, as we are continuously improving our products in our commitment to quality, reliability and ease of use. Let us know via <a href="mailto:sales@vpinstruments.com">sales@vpinstruments.com</a>!</p>

## 2 Introduction

Congratulations! **You purchased the easiest to use and most complete compressed air measurement tool in the world.** With the VPFlowScope In-line, you can monitor and record flow, pressure, temperature, and total air consumption, simultaneously.

Great products deserve great user manuals. We have done our best to make this user manual as complete as possible. New users, please read it carefully to familiarize yourself with our products. Experienced users can check out the [Quick start chapter](#).

Check the packaging box for any inconsistencies. Should there be any shipping damage, notify the local carrier. At the same time a report should be submitted to Van Putten Instruments BV, Buitenwatersloot 335, 2614 GS DELFT, The Netherlands.

**This manual is dedicated to:**

VPS.R080.M050.DXX Where DXX indicates the display type

VPS.R250.M100.DXX Where DXX indicates the display type

VPS.R01K.M200.DXX Where DXX indicates the display type

For latest VPStudio software and overview of latest firmware versions, please visit [www.vpinstruments.com](http://www.vpinstruments.com).

Older software features may not be covered by the contents of this user manual. Please contact us for a service subscription program, which includes software and firmware updates!

### 3 Product overview

The VPFlowScope In-line measures mass flow, temperature and pressure simultaneously. All these parameters are key to proper compressed gas measurement and are therefore included in all models. All data can be accessed by Modbus RTU, 4 .. 20 mA and pulse.

The VPFlowScope In-line is available in three configurations to fit every application. Use the connector cap for sensor features only, ideal for integration into a central management system. Use the display module for central read out and data logging. Use the VPFlowTerminal for central read out and data logging on location where a standard display can not be read out. For all models, all parameters and outputs are available.



The VPFlowScope In-line is available in three sizes: 0.5", 1" and 2". Additional options are available for all types:

Order Code	Flow range	Option	Display	Option	Connector
VPS.R080.M050	0 .. 80 m <sup>3</sup> /hr	D0	No display	C5	5 Pin M12
VPS.R250.M100	0 .. 250 m <sup>3</sup> /hr	D10	Display	C8	8 Pin M12, for remote logging *
VPS.R01K.M200	0 .. 1000 m <sup>3</sup> /hr	D11	Display + 2M point logger		

\* An 8 Pin M12 connector can only be ordered in combination with a D0 model.

Order the VPFlowScope In-line KIT to receive the complete start kit with all required accessories, everything you need to get started right away.

#### 3.1 Configuration

The instruments are pre-programmed and ready to use. For configuration of the outputs and data logger, the VPStudio configuration software is used. This software can be downloaded from our website. [www.vpinstruments.com/downloads](http://www.vpinstruments.com/downloads)

### 3.2 VPFlowScope In-line D0 (no display)

The D0 model can be used in applications where local read-out and data logging is not required. With its various outputs the VPFlowScope In-line can be connected to remote data loggers.

### 3.3 VPFlowScope In-line D10 & D11 (display version)

The D10 and D11 models add a 3 row display with keypad to the VPFlowScope In-line. All parameters will be shown on the display in real time. The keypad can be used to start a data log session or to change the key parameters of the VPFlowScope In-line. The D11 model also features a 2 Million point data logger. All output parameters for remote connection remain available on the M12 connector.



1. Menu / Enter button
2. Esc / Record button
3. Down button
4. Up button
5. LCD display
6. USB interface
7. M12 connector

### 3.4 VPFlowScope In-line D0 with the VPFlowTerminal

The VPFlowTerminal can be used as a remote display for situations where the local display can't be read. All display features will be available on the remote display.

The VPFlowTerminal is equipped with a 10 m / 32.8 ft. cable with M12 8-pin connector. Therefore the D0 model needs to be ordered with an M12 8-pin connector. The VPFlowTerminal features a 2 Million point data logger which can record both the flow meter and the analog inputs.

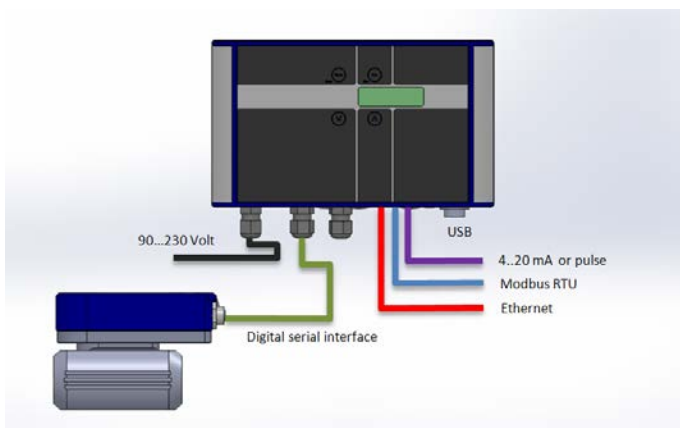



## 4 Quick start

This chapter contains the basic steps to start using your VPFlowScope In-line flow meter. Additional information on all subjects can be found in the next chapters.

### 1. Unpack

Unpack the meter and check if all items are there and in good shape. A checklist with all items is available on the box.

### 2. Mechanical installation

- Find the best point of installation for this product. Make sure that all specifications are met.
- For installation of the VPFlowScope In-line, the pipe needs to be cut. Mount the VPFlowScope In-line between the pipe ends. Use tri-clamp or similar adapters for quick installation and removal.
- For installation with the tubing kit: The connection is BSP outer straight thread [For NPT thread, chase the BSP thread of the pipe ends with a die]; 0.5", 1" or 2" depending on the VPFlowScope In-line model.
- For installation without tubing kit: The connection is BSP inner straight thread [It can accept NPT male thread ends]; 0.5", 1" or 2" depending on the VPFlowScope In-line model.

See chapter [mechanical installation](#) for more detailed information.

### 3. Electrical installation

#### 3.1 Permanent installation

Connect a cable with 5 Pin M12 connector to the VPFlowScope In-line. The cable can be connected to a central data acquisition / building management system or data logger via Modbus, 4 .. 20 mA or pulse. See chapter [electrical connections](#) for more information.

Apply 12 .. 24 VDC to power up the device. Use a Class II power supply (less than 2 Amps). If the built-in display option is available, it will light up when power is applied.

#### 3.2 Temporary installation

Use a 12 .. 24 VDC Volt power supply with M12 connector to power the VPFlowScope In-line. This quick method is ideal for audits.

### 4. Data recording

When the data logger is available a data log session can be started by pressing the esc button and then enter. All parameters will be logged with the default logging intervals (5 seconds for all parameters). These logging intervals can be changed with the VPStudio software. This software tool is also used to retrieve the recorded sessions.

## 5 Measurement

For all parameters the update interval is 1 second. Within this second, multiple samples are taken and averaged to provide a stable and reliable output.

### 5.1 Flow

The VPFlowScope In-line uses our proprietary insertion type thermal mass flow sensor. There is no bypass flow, which results in a high robustness and less sensitivity for dirt or particles. The flow sensor is directly temperature compensated.

The sensor response signal is directly related to the mass flow rate and can be described by the following formula:

$$V_{out} = k * \rho * v * (T_s - T_g)$$

$V_{out}$  = output voltage

$k$  = sensor (geometrical) constant  
= thermal conductivity of the gas  
= density of the gas

$v$  = actual velocity in m / sec

$T_s$  = sensor temperature

$T_g$  = gas temperature

The optional bi-directional sensitivity is shown in the picture on the right. In bi-directional mode the negative flow value will show up as a minus sign. The 4 .. 20 mA value needs to be adapted to suit the application. [See chapter 9.1 for details.](#)

**No flow**  
Everything in balance.

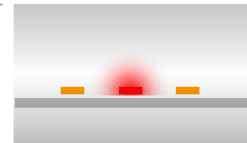

**Flow from left**  
The left part is cooled down; the right part of the bridge is heated up.



**Flow from right**  
Vice versa! Now the left part is heated up and the right part is cooled down.

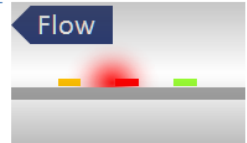

### 5.2 Pressure

The VPFlowScope In-line features a built-in gauge pressure sensor. The sensor range is 0 .. 250 psi, rounded off this equals 0 .. 16 bar gauge. The sensor cannot measure vacuum, please contact us if you have a vacuum application. The sensor membrane can handle media which are compatible with glass, silicon, stainless steel, Sn/Ni, plating and Au/Ag solder.

The sensor signal is sampled with 16 bits. The practical resolution is 0.24 mbar on the 0 .. 16 bar scale, which is equal to 0.004 psi on the 250 psi scale.

### 5.3 Temperature

The built in temperature sensor measures the compressed air/ gas temperature. It is mounted in a separate position, to ensure quick response time and low self-heating of the sensor element.

The signal is sampled with 16 bits. The resolution is less than 0.1 °C | 0.18 °F.

In a vertical pipe, with flow going down, the temperature sensor may heat up at zero flow conditions, due to the heated flow sensor element. This effect will disappear as soon as there is consumption.

For optimal measurement performance, the VPFlowScope In-line needs to be in a stable temperature environment. When exposed to quick temperature changes or large temperature changes (for example taking the unit from outdoor to indoor during winter time, or when mounted downstream of a heat regenerated drier) the temperature compensation may lag behind, which may result in significant measurement errors.

## 5.4 Totalizer

The totalizer keeps track of the total consumed amount of compressed air in normal cubic meters, or in scf depending on which unit you choose to read out. The refresh interval is 1 second, actual measurement data will be available on the display and by Modbus. For back up reasons, the totalizer value is written to it's internal memory with an interval of 15 minutes. A power down might result in maximum 15 minutes of totalizer data loss.

In bi-directional operation, negative flow is subtracted from the totalizer. The totalizer will count backwards as the compressed air is delivered back to the supply side. The totalizer can only be reset to zero. It's not possible to set it to a different value.

The display will show totalizer values up to 999.999,9 and will then become 0,0 independent of the taken unit. This will not clear the internal totalizer.

## 6 Mechanical installation

First select the right installation point. The installation point is crucial for the right measurements. Sources of error can be: installation effects, unknown flow profiles, swirls, pressure and temperature effects, humidity effects or oscillations in the flow. To ensure the highest possible accuracy of flow measurement, the installation and piping instructions must be followed. Therefore read this paragraph carefully.

Take into account:

- Choose a site which is accessible, which allows ease of wiring and maintenance, and which allows you to still read and access the display when needed.
- Meet the specifications of the VPFlowScope In-line. If the specifications are not met, for instance the pressure or temperature level is too high; this will cause inaccurate flow measurement and can even damage your flow meter.

Avoid:

- Excessive heat, check the temperature range of your VPFlowScope In-line.
- Potential water damage on the outside. Avoid areas of high humidity and avoid dripping. Be aware that the VPFlowScope In-line is not watertight, it is only IP65 (when mated with the USB protection cap).
- Corrosive atmosphere where possible.
- Electrical problems (high voltage/ high power).
- Mechanical vibration and danger (walking bridges, fork lift trucks).



Stop: These devices are only for use with Air, Nitrogen and other non hazardous and non combustible gases. The maximum working pressure is 16 bar (250 psi)

Arrêt: Ces dispositifs sont uniquement destinés à être utilisés avec de l'air, de l'azote et d'autres gaz non dangereux et non combustibles. La pression opérationnelle maximale est de 16 bar (250 psi)

### 6.1 Piping table

Check the piping table below and match it for your application. The table shows the amount of upstream and downstream length depending on the installation. If applicable in front of the meter, use given upstream length. If applicable in behind the meter, use given downstream length. Gas flow in pipes follows certain rules, which must be observed for optimal measurement results. In some cases the upstream length needs to be longer, in other cases it can be shorter.



If possible choose a longer upstream length, as these are minimum values. The up- and downstream lengths are used industry wide as guidelines, but will never be a guarantee for obtaining the "true value". So always be careful and try to build up your own experience from practical measurements

#### Piping table

The following table provides a guideline for proper distances between upstream or downstream objects and the VPFlowScope In-line. The upstream length is the length between the last non-straight object and the VPFlowScope In-line. If the upstream length is straight, and the distortion is downstream of the VPFlowScope In-line, you can use the column "downstream length" as a guideline. In very complex situations, with multiple up- and downstream objects, you should consider another location. This table is a practical guideline and is not exact science. Practical situations can have multiple sources of distortion, therefore VPInstruments does not take any responsibility for the correctness.

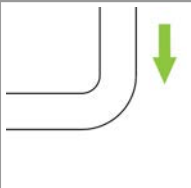
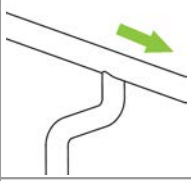
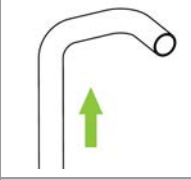
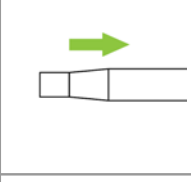
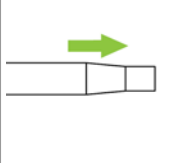
Picture	Description	Upstream length <sup>2</sup>	Downstream length <sup>2</sup>	Effect
	Single elbow	30 * D1	10 * D1	Distorted flow profile
	Complex feed-in situation (header)	40 * D1	10 * D1	Flow profile will be distorted
	Double elbow, multiple elbows following each other	40 * D1	10 * D1	Distorted profile + swirl
	Diameter change from small to large (gradual or instant)	40 * D1	5 * D1	Jet shaped flow
	Diameter change from large to small (gradual change, between 7 and 15 degrees)	10 * D1	5 * D1	Flattened flow profile

1 = inner diameter; 2 = minimum length

## 6.2 Installation without tubing kit

When you order your VPFlowScope In-line as a base model only, it is delivered without up- and downstream piping. You can install it directly between two threaded pipe ends. Please be aware that the connection between the pipe and the VPFlowScope In-line is very important. Any diameter mismatch will result in higher inaccuracy. For example the inner diameter of the pipe may affect the reading. Depending on the pipe wall thickness, the inner diameter can be smaller, which results in a higher measurement value. If you want to be sure of the connection, ask us to supply you with the piping kit.

The connection is BSP inner straight thread; 0.5", 1" or 2" depending on the VPFlowScope In-line model. For NPT thread, chase the BSP thread of the pipe ends with a die.

## 6.3 Installation with tubing kit

If you ordered the tubing kit or a full start kit, the VPFlowScope In-line is delivered with an optimized up and downstream piping kit, to ensure the best possible connection to the VPFlowScope In-line. For economical reasons, the inlet tubes provide a limited upstream length. For optimum results, see the piping table and create additional upstream pipe length.

Check the pipework and the O-rings, which are pre-mounted on the pipes. Apply a little O-ring grease to ease the mounting process. Screw both pipes into the VPFlowScope In-line. Gently screw the

pipes into the flow meter inlet. Turn it all the way in, until the end of the pipe reaches the bottom of the inlet hole

You can install the VPFlowScope In-line directly between two threaded pipe ends. The connection is BSP outer straight thread or NPT Taper; 0.5", 1" or 2" depending on the VPFlowScope In-line model.

## 6.4 Installation instructions

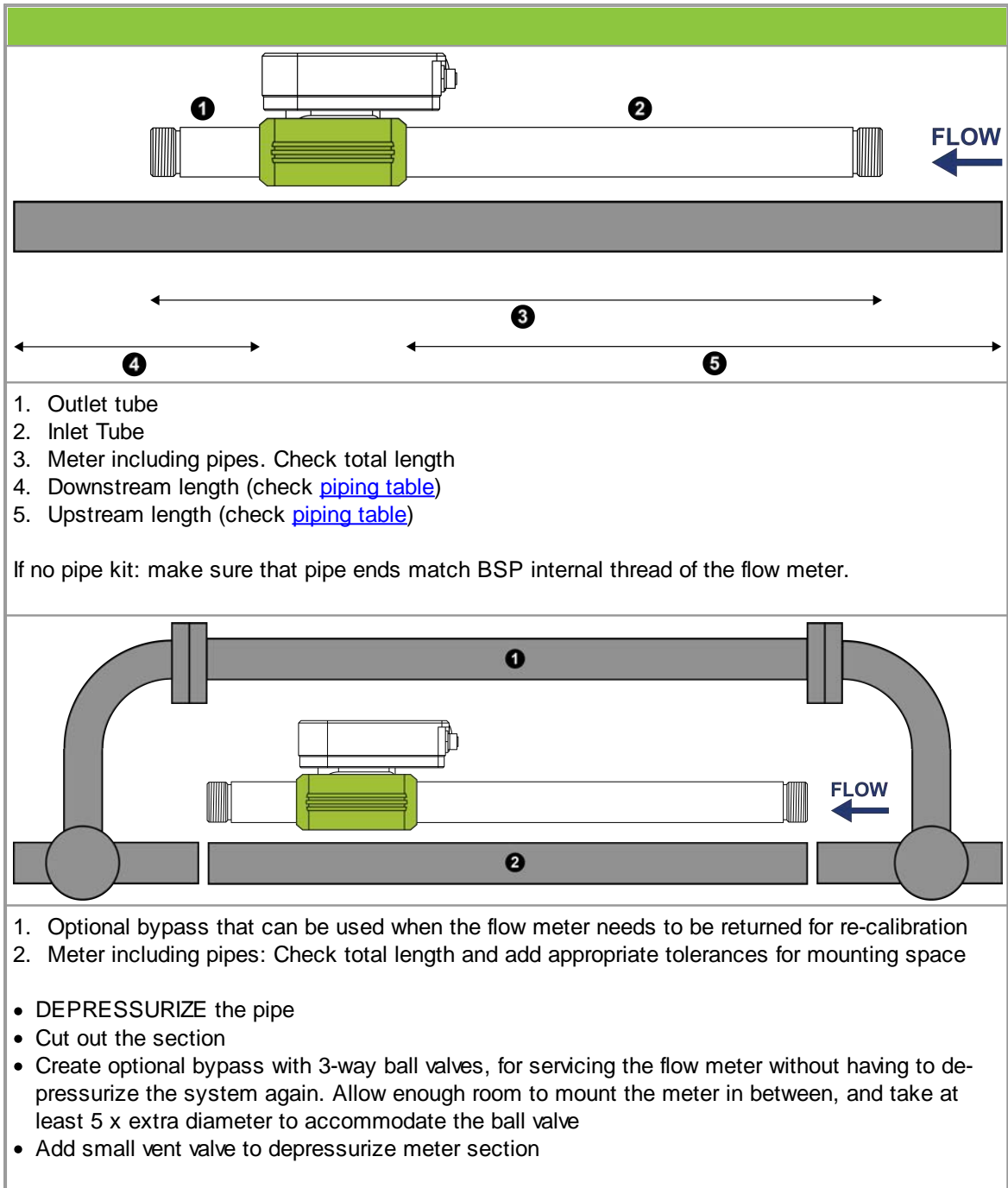

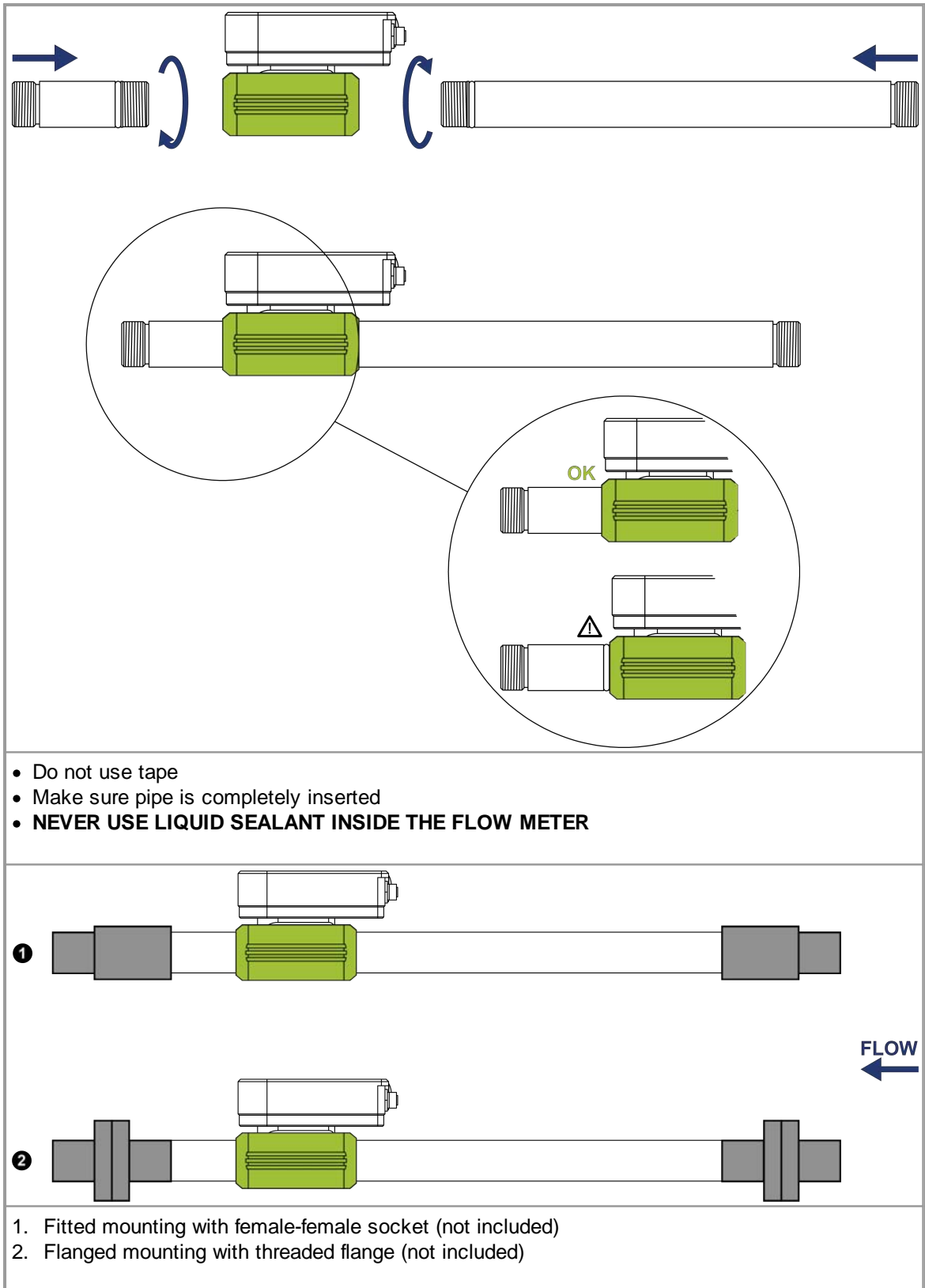

## 7 Display

The display provides some additional features:







- LCD display with 3 rows of real time data, refreshed every second
- Key pad with menu to configure the main settings
- Data logger with adjustable logging intervals (option)
- 5 custom units (multiply an existing unit with a factor and show it on the LCD display).  
Configuration can be done with VPStudio.

By default, the display will show 3 rows of measurement data in the factory default units:  $m^3_n/hr$ , deg C and bar (g). The menu can be entered to change the configuration. See section [menu](#) for all configuration options.

The VPFlowScope In-line requires 12 .. 24 VDC for proper operation. A "no external power" message will be shown when the device is only powered through USB.

### 7.1 Display status icons

Some status icons show feedback on the meters' status. Below is a list with explanation

Icons	Description
	Sensor module is properly connected and supplied with power
	No communication with the sensor [Check external power when disconnected]
	A blinking dot will indicate that a data session is active
	2 rotating arrows indicate that there is communication with the computer
	The display is locked. The menu can not be accessed
	Memory indication. Each block indicates 20% of memory usage. The blocks start to blink if the memory is more then 95% full

### 7.2 LCD display

The LCD display provides 3 rows for real time data. Each row can be configured in the display menu by selecting the desired parameter for this row.

Available options are listed in [menu -> display](#).



## 7.3 Data Logger

The optional integrated data logger offers you 2 Million data points. Enough to measure all three channels 1 x per second for more than a week. Use the following guidelines for the intervals

Application	Flow	Pressure	Temperature	Estimated log time*
Standard energy management application	5 min	5 min	5 min	2314 days
Machine testing - quick fluctuations	1 sec	1 sec	1 sec	7 days
Audit - one week	10 sec	10 sec	5 min	113 days
Audit - one month	30 sec	30 sec	5 min	330 days

\* Log time with empty data logger

Multiple sessions can be recorded on the data logger. For each time a session is started, a new session will be recorded. It's not possible to append to an existing session.

When a power failure occurs during recording, the session will be aborted. When power is restored, a new session will start automatically.

## 7.4 Keypad

The key pad contains 4 buttons to control the display.



- |   |                 |  |
|---|-----------------|--|
| 1 | Menu / Enter    | Used to enter the (sub)menu or to confirm a setting  |
| 2 | Escape / Record | Will start a data logging session when in the data acquisition screen.<br>Will return from a (sub)menu when not in the data acquisition screen |
| 3 | Button down     | Navigate down in the menu  |
| 4 | Button up       | Navigate up in the menu  |

### Special key functions

- Lock display

In the main screen, press up and down simultaneously to lock or unlock the display. A lock icon will appear in the right lower corner of the screen. The lock function will block keypad functionality.

- Clean re-boot.

Hold sec pressed when turning the power on. Use this option when a display will not start up or if a session won't stop. This can happen due to subsequent power failures at the moment that the memory is almost full.

## 7.5 Menu

The menu is categorized into 3 main items which contain their own sub menu items. The complete menu structure is shown below:

1. Settings
  1. Display
  2. Date and Time
  3. Modbus address
  4. RS485
  5. Display dim time
  6. Display orientation
2. DAQ Sessions
  1. New Session
  2. Delete all
3. Advanced
  1. Reset

### 1 Settings

The settings menu can be used to change both functional parameters as display settings.

#### 1.1 Display

The main screen of the display contains 3 rows to display measurement values. Via this menu measurement values can be assigned to these rows. Select the desired unit for row 1 and hit enter to configure row 2. Repeat the above to go to row 3. Available units are:

Measurand	Available units	Description
Empty	-	Leave this display row empty
Flow	m <sub>n</sub> /sec m <sup>3</sup> <sub>n</sub> /h l <sub>n</sub> /min SCFM m <sup>3</sup> <sub>n</sub> /min sfps	Normalized
Pressure	bar psi	Gauge
Temperature	°C °F	
Totalizer	m <sup>3</sup> <sub>n</sub>	Normalized
Custom		5 available units to be configured with VPStudio. Multiply an existing unit with a user defined factor.

#### 1.2 Date and Time

Adjust date and time settings. First enter the menu option and set the date with the key pad. The date is formatted as: DD-MM-YYYY. After setting the date, confirm with enter and then enter the time settings in format: HH:MM:SS, again confirm with enter. The new date will become active immediately.

Date/time settings are kept actual by the real time clock until long power down. Date and time will also be synchronized with the computer when used with VPStudio. Pressing the store button will trigger the synchronization.

### 1.3 Modbus address

The Modbus address can be changed with this option. Use the up and down buttons to change the number. Available numbers 1 – 247.

After setting the number press enter to save the address. The power of the VPFlowScope In-line needs to be cycled to activate the new address.

### 1.4 RS485

The RS485 communication parameters baud rate, parity and stop bits can be changed in this menu. After changing the settings, press enter to save them. The power of the device needs to be cycled to activate the new settings.

### 1.5 Display dim time

The display back light dim time can be adjusted here. The default dim time is set to 10 seconds.

Other Available options are:

- Fading off. The back light will remain on.
- 5 till 30 seconds with steps of 5 seconds.

Confirming with menu will make this setting immediately active.

### 1.6 Display orientation

The text on the display can be rotated upside down for installations were the text needs to be mirrored. Enter the menu item and select the desired orientation with the arrow keys. Confirm with enter to make these settings active.

All keys will maintain their function.

## 2 DAQ Sessions

The VPFlowScope In-line contains an optional 2 Million point data logger. When available, the menu is set to start and stop the sessions or to delete all present data.

### 2.1 Start session

The session will be started when you push the enter button after selecting this option. When the session is started, the menu will close and the main screen will be shown. A blinking dot in the right upper corner will indicate the running session. The menu will be blocked when a session is active. The session can be stopped by pressing the esc button.

### 2.2 Delete all

All sessions will be deleted. It is not possible to delete just a single session.

## 3 Advanced

### 3.1 Reset

Reset the device. All peripherals will be reinitialized. This option is also needed when updating the display firmware.

## 8 VPStudio software

The VPFlowScope In-line can be read out and configured with the VPStudio software. This software can be downloaded from [www.vpinstruments.com](http://www.vpinstruments.com).

In case of basic configuration and read out, use the free edition. If real time logging is required, request a license code by our sales department.

A quick start is shown below, read the VPStudio manual for more information. This manual can be downloaded from [www.vpinstruments.com/downloads](http://www.vpinstruments.com/downloads)

### **Connect the VPFlowScope In-line to the computer**

The VPFlowScope In-line can be connected to the computer with the M12 connector through the JB5 interface box. This interface box combines the power and data signals. Power up the device by connecting the 12 .. 24 VDC power supply to the JB5 interface box. A RS485 to USB converter can be used to connect the JB5 interface box to the computer.

When a display is available, the VPFlowScope In-line can also be connected by USB. When connected via USB, you can only download data log sessions and configure the display. For full functionality you need to connect an additional DC power supply via the M12 connector. We offer a convenient power supply for this purpose (VPA.0000.200)

### **Install USB drivers**

A driver needs to be installed for the RS485 to USB converter. The driver might be installed automatically by your windows system or need to be installed manually. All drivers are available on our website [www.vpinstruments.com/downloads](http://www.vpinstruments.com/downloads). All drivers are enclosed with the download of VPStudio and can be found in the installation folder.

### **Configure the VPFlowScope In-line**

- Start the VPStudio software
- In the left white window, right click to open the menu. Now click add device
- Click the scan button to search for the right COM port. Select it and click add
- Enter a name for the device
- Now select serial for RS485 converter or USB if the meter is connected with USB
- Set the communication parameters if available
- Click add.

### **VPFlowScope In-line sensor read out**

- Click on the device in the explorer window to read out the settings
- The status tab provides general information
- The installation tab is used to configure the settings

### **VPFlowScope In-line display read out [option]**

- Click on the plus icon to unfold the display icon
- Click on display to read out the display settings
- The status tab provides general information
- The installation tab is used to configure the settings
- Click sessions below display to retrieve session data.

## 9 Electrical connections



NEVER USE AC POWER. THIS WILL VOID WARRANTY AND BRING PERMANENT DAMAGE TO THE ELECTRONICS. THE INSTRUMENT MIGHT BE DAMAGED BEYOND REPAIR.  
CONNECT THE M12 CONNECTOR BEFORE POWERING UP THE INSTRUMENTS.

The VPFlowScope In-line provides a 4 .. 20 mA / pulse output and a Modbus output. All signals are present in the M12 connector. These outputs can be used to connect the VPFlowScope In-line to a building management system or energy monitoring system like VPVision.

Pin	Signal	Wire color*
1	+12 .. 24 VDC	Brown
2	0 Volt	White
3	4 .. 20 mA signal, active	Blue
4	RS485 B	Black
5	RS485 A	Grey

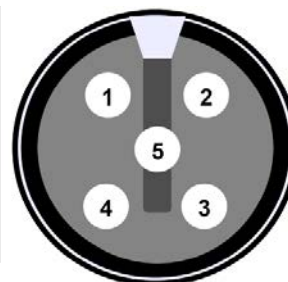

M12 5-pin female connector

\* Wire colors apply to VPInstruments cables

### Cabling

Shielded twisted pair cabling must be used for proper communication and measurement. Connect shield to safety ground on one point. The thickness of the wires depends on the cable length. For cabling below 300 meter | 1000 ft, use 20 awg. For longer runs use 18 awg or better.

### Power supply

The input voltage is 12 .. 24 VDC. Make sure that the power supply is at least 12V at the connector. Voltage drops will occur in long cables resulting in insufficient power. The display will notify you when there is insufficient power.

### 9.1 4 .. 20 mA output

The 4 .. 20 mA output is an active, non- isolated linearized current loop that can be used to connect the VPFlowScope In-line to a control system, a building/processing management system or any 4 .. 20 mA based system.

There is one 4 .. 20 mA output available on the VPFlowScope In-line. This output can be assigned to one of the measurement parameters, only one can be selected. For each measurand, a number of units is available. The factory default is  $m^3_n/hr$ .

Measurand	Unit
Flow	$m_n/sec$
Flow	$m^3_n/hr$
Flow	$l_n/min$
Flow	SCFM
Flow	$m^3_n/min$
Flow	sfps
Pressure	bar
Pressure	psi
Temperature	°C
Temperature	°F

For scaling purposes, the zero and span matching 4 and 20 mA can be modified. This will not effect the original measurement range. The zero and span are only used to increase or narrow the resolution. For bi-directional measurement, the zero value needs to be set negative. See below table for factory defaults.

Mode	Zero	Span	Idle output
Single direction	0% flow range	100% flow range	4 mA
Bi directional	-100% flow range	100% flow range	12 mA

### Configuration with VPStudio

VPStudio can be used to configure the 4 .. 20 mA settings. Use the select box to choose the preferred unit that will be assigned to the output. Set zero and span to the preferred values.

Changing to volumetric units, the programmed diameter is calculated in the settings. VPStudio provides feedback while you are changing the settings. Use "set default" to go back to the factory default.

### 4 .. 20 mA output

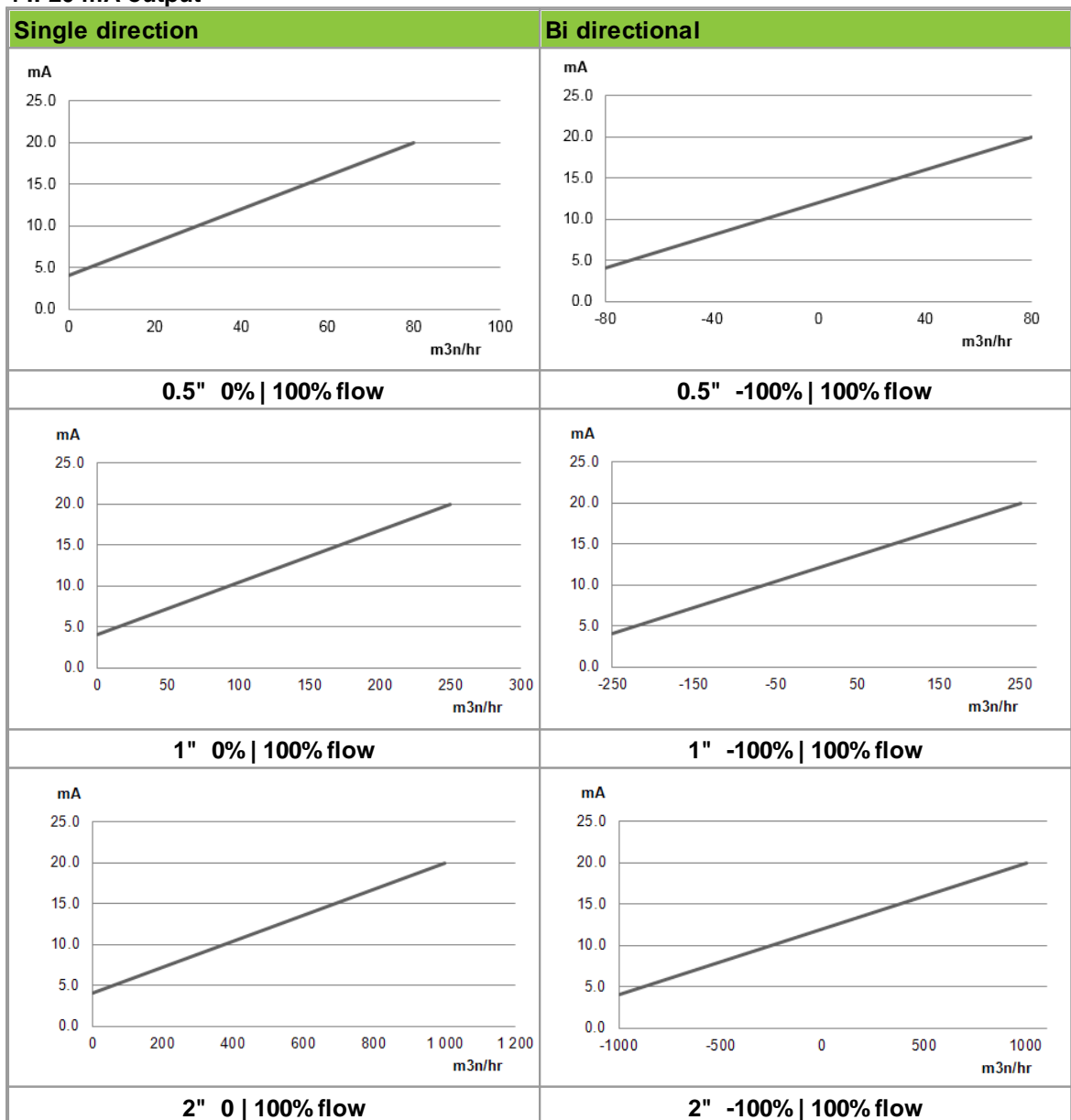

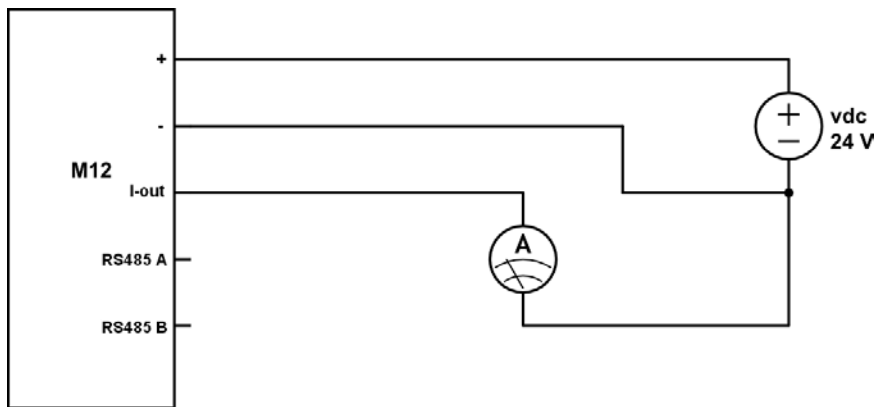
**Electrical scheme:**

The current meter is placed in between the current output and the power supply ground. You can also use a digital multimeter to test the current output.

## 9.2 Pulse output

The VPFlowScope In-line features a low-frequency active pulse output. The pulse is a 'non potential' free output as it acts like a controlled current output. To make it passive, an external isolator can be used.

The pulse interval can be set with the VPStudio software. A pulse from 0 .. 20 mA will be generated when the interval exceeds. The maximum pulse frequency is once per 2 seconds. If the pulse interval is set too small, a continuous pulse (20mA high level) will be the result.

The pulse output is connected to the internal totalizer value. When the totalizer has increased by the pulse interval, the pulse will be generated. As it is not possible to generate a negative pulse, negative flow can not be indicated by pulse. In case of negative flow, the internal totalizer will count backwards. Pulses will not be generated until the same amount of positive flow has been added to the totalizer again. In this way we ensure that the pulse output will always be synchronized with the internal totalizer of the VPFlowScope In-line. In case of continuous negative flow, consider to change the flow meter direction.

### Default settings

Diameter	Diameter	Pulse interval
< 25 mm	< 0.5 inch	0.1 m <sup>3</sup> <sub>n</sub>
> 25 mm and < 45 mm	> 0.5 inch and < 1 inch	0.2 m <sup>3</sup> <sub>n</sub>
> 45 mm	> 1 inch	1 m <sup>3</sup> <sub>n</sub>

### Pulse output

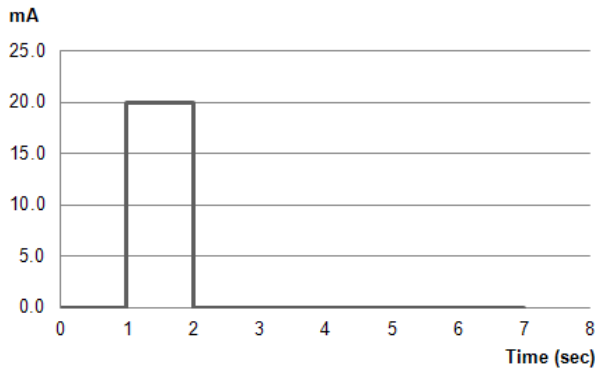

### Electrical scheme:

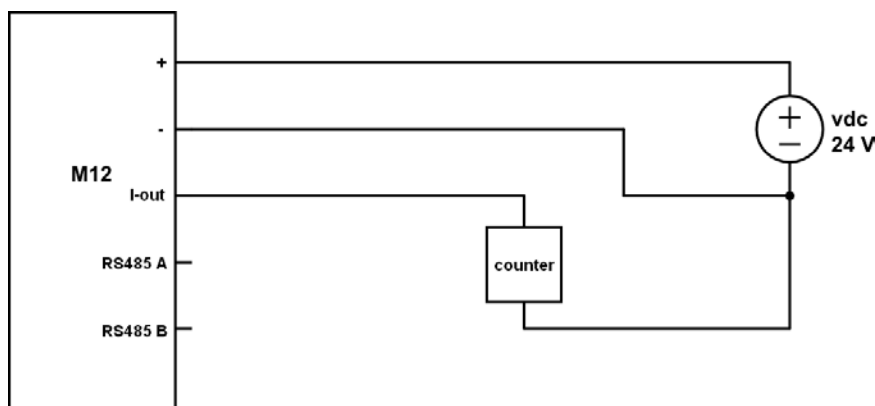



## 9.3 Modbus interface

### Introduction to Modbus

For a complete introduction on the Modbus standard can be found on [www.modbus.org](http://www.modbus.org). See the document [Modbus\\_over\\_serial\\_line\\_V1\\_02.pdf](#), which can be downloaded from their website. We strongly recommend to download and read this information carefully before installing Modbus communication. The following paragraphs in this chapter assume you are familiar with the Modbus communication standard.

All measurement parameters are available through Modbus in floating point and integer format. The data will be refreshed every second. Maximum polling interval is 10ms.

### Communication settings

The RS485 communication settings can be changed with VPStudio. Below shows the available options

- Baud rate: 9600 | 19200 | 38400
- Stop bits: 1 | 2
- Parity: None | Even | Odd

The Modbus settings can be changed with VPStudio, the hardware address can also be changed with the keypad when available. Below shows all available options

- Hardware address: 1-247
- Integer multiplier: 1-1000

### Data format

Function code 0x03 for reading(Holding register)

Function code 0x10 for writing (Holding register)

32-bit Floating point Little endian [CDAB]

32-bit signed Integer Little endian [CDAB]

### Factory default settings

Parameters	Value
Baud rate	38400
Stop bits	1
Parity	None
Hardware address	9
Integer multiplier	10

### Register map

The actual measurement data is placed in holding registers. To read out data, you will need to use the corresponding holding register. All data is stored in 2 16-bit registers with below register number as start address. Read out the data with this start address and length 2.

Decimal	HEX	Description	Type	Read / Write
16	0x10	Flow in $m_n$ /sec	32-bit integer (x10)	Read
17	0x11	Flow in $m_n^3$ /hr	32-bit integer (x10)	Read
18	0x12	Flow in $l_n$ /min	32-bit integer (x10)	Read
19	0x13	Flow in SCFM	32-bit integer (x10)	Read
20	0x14	Flow in $m_n^3$ /min	32-bit integer (x10)	Read
21	0x15	Flow in sfps	32-bit integer (x10)	Read
32	0x20	Pressure in bar	32-bit integer (x10)	Read
33	0x21	Pressure in psi	32-bit integer (x10)	Read
64	0x40	Temperature in °C	32-bit integer (x10)	Read
65	0x41	Temperature in °F	32-bit integer (x10)	Read
128	0x80	Totalizer in $m_n^3$	32-bit integer (x10)	Read / Write*

\* Writing to the totalizer will reset the totalizer to zero.

Decimal	HEX	Description	Type	Read / Write
8	0x08	Diameter	32-bit Floating point	Read
9	0x09	4 .. 20 mA Max	32-bit Floating point	Read / Write
10	0x0A	4 .. 20 mA Min	32-bit Floating point	Read / Write
11	0x0B	4 .. 20 mA Unit	32-bit Floating point	Read / Write
24	0x18	Flow in $m_n$ /sec	32-bit Floating point	Read
25	0x19	Flow in $m_n^3$ /hr	32-bit Floating point	Read
26	0x1A	Flow in $l_n$ /min	32-bit Floating point	Read
27	0x1B	Flow in SCFM	32-bit Floating point	Read
28	0x1C	Flow in $m_n^3$ /min	32-bit Floating point	Read
29	0x1D	Flow in sfps	32-bit Floating point	Read
40	0x28	Pressure in bar	32-bit Floating point	Read
41	0x29	Pressure in psi	32-bit Floating point	Read
72	0x48	Temperature in °C	32-bit Floating point	Read
73	0x49	Temperature in °F	32-bit Floating point	Read
136	0x88	Totalizer in $m_n^3$	32-bit Floating point	Read / Write*

\* Writing to the totalizer will reset the totalizer to zero.

### Available write operations

Option	Data	Description
4 .. 20 mA unit	0 1 2 3 4 5 6 7 8 9 Other	$m_n/\text{sec}$ $m_n^3/\text{hr}$ $l_n/\text{min}$ SCFM $m_n^3/\text{min}$ sfps bar psi °C °F $m_n/\text{sec}$
4 .. 20 mA min	Decimal value	
4 .. 20 mA max	Decimal value	
Totalizer	Integer or floating point type depending on register type	Will reset the totalizer to zero



Installing a RS485 network require specific knowledge. Not following the specifications strictly might result in incorrect communications and equipment damage. Please leave installation up to professional contractors. Make sure that they read this chapter carefully and follow up all RS485 guidelines.

RS485 is a differential balanced line over twisted pair. It can span relatively large distances up to 1200 meter | 4000 feet. The wires should be connected as a point-to-point configuration, or also called daisy chain. Do not install as star or ring network! The trunk line goes from the master to all devices making a drop down to each device. The cable length from the trunk line to the Modbus device needs to be as small as possible. Junction boxes are used to make the T junction.

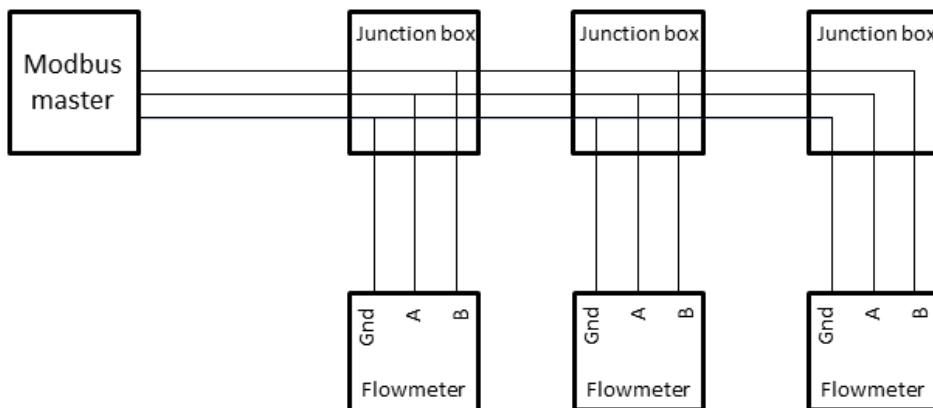

Shielded twisted pair should be used. Connection of a third wire between the master and slave should be done to limit the common mode voltage that can be impressed on the slaves inputs. The required cable quality depends on the total cable distance, the number of nodes and the environmental influences. A local contractor can help you select the right cable for your application.

### Termination resistor

Termination resistors reduce electrical noise sensitivity. They need to be added to the installation when cable distances become longer than 10 meter. The value of each termination resistor should be equal to the cable characteristic impedance (typically, 120 ohms for twisted pairs).

There can only be one termination resistor at the very end of the trunk line. The VPInstruments junction box features a jumper that can be used to enable a 120 Ohm resistor. When using the VPInstruments Modbus Junction boxes make sure that the 120 Ohm resistor is only enabled in the last Modbus Junction box in the daisy chain.

### Biasing

When there is no data activity on an RS485 network, the communications lines are "floating" and, thus susceptible to external noise or interference. Receivers on a RS485 network have built in hysteresis (200mV differential required to insure known state). To insure that a receiver stays in an inactive state, when no data signal is present, bias resistors are required. Bias resistors are a pull-up resistor on Modbus B and a pull-down resistor on the Modbus A line. The value of the bias resistor depends on the number of devices and the supply voltage. The table below shows which resistor values can be used for different voltage in a chain with 1 to 8 VPFlowScopes In-line.

Supply voltage	Bias pull up	Bias pull down
12 V	5 K	1 K
24 V	10 K	1 K

### Bus power

The VPFlowScope In-line can be powered via the same trunk line. 2 separate wires are used for power + and power -. Take in account that long wires with multiple slaves will cause voltage drops. The minimum supply voltage is 12VDC measured at the last VPFlowScope In-line in the daisy chain.

### Electrical scheme

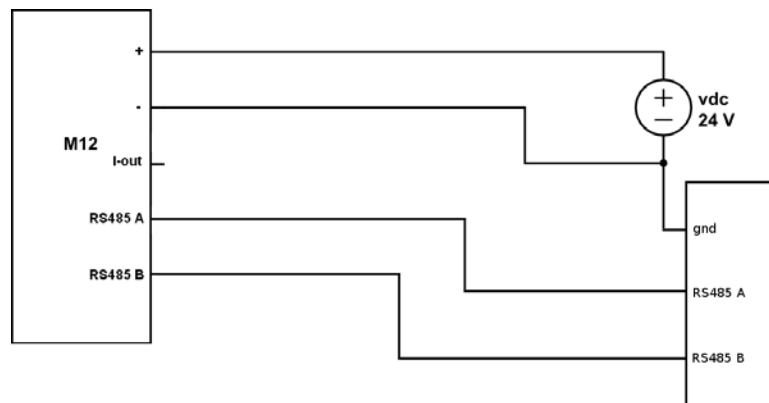

## 9.4 USB interface

The VPFlowScope In-line D10 and D11 model offer a built-in USB interface for configuration and data log session retrieval. The USB interface is protected by an IP65 rated nylon cap. **IMPORTANT:** the IP65 rating may be compromised when this cap is damaged or not placed back in a proper manner. To ensure proper sealing, the cap must be greased with a little o-ring grease or Vaseline grease. Make sure that the grease is not in contact with the electrical connector!

A standard USB cable with mini connector can be used for connection to a PC or laptop. The USB interface is not designed for permanent use.

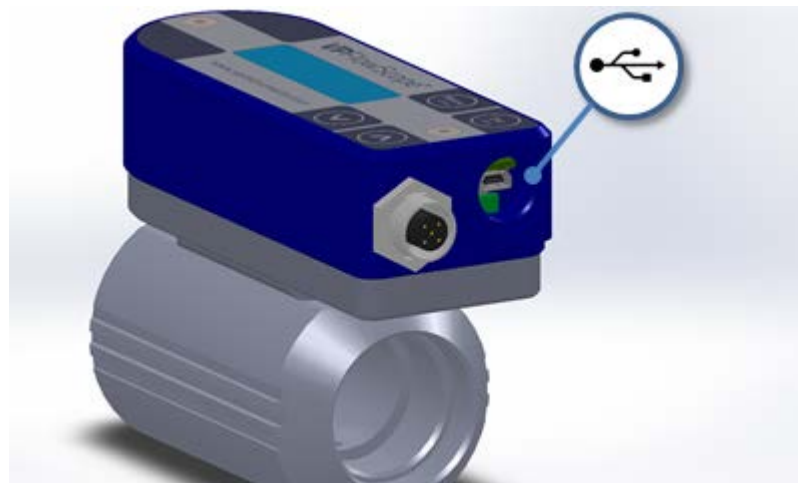

## 10 Service

The VPFlowScope In-line needs regular maintenance to ensure that the product is functioning properly. Especially when the product is used for mobile air audits, we recommend inspecting the instrument before and after every audit to ensure that the product has not been damaged. For precision measurement equipment such as the VPFlowScope In-line, a proper maintenance program is key to reliable measurement results and a long product lifetime.

### 10.1 Software and firmware updates

News on software and firmware updates can be found on [www.vpinstruments.com](http://www.vpinstruments.com), or are provided by your local re-seller. The VPFlowScope In-line sensor can be updated via the RS485 port. The USB interface is used for updating the firmware of the display. Instructions on the update procedure can be found in a separate instruction leaflet, which is distributed on request. Upgrading is only possible for authorized technicians, at own risk.

### 10.2 Calibration interval

The quality of the compressed air or gas you are measuring could influence the accuracy of this product. VPInstruments guarantees the accuracy, as indicated on the calibration certificate or in the product specifications. This accuracy will remain valid until the moment of commissioning within the first 36 months after purchasing this product under the following conditions:

- The product is stored indoors in a dry, frost free environment.
- Vibrations and heavy shocks should be avoided during transport and storage.

If this product is not commissioned within 36 months after the initial purchase we highly recommend to send the product back to VPInstruments for check-up and re-calibration.

Once the product is put into operation, the calibration interval depends on the quality of the gas. If the quality of the gas is unknown, VPInstruments advises annual recalibration. The latest calibration date can be found in VPStudio.

### 10.3 Service subscriptions

VPInstruments offers several Service Subscriptions. Enrolling in a Service Subscription helps you get the most out of your measurement equipment. We keep your equipment in excellent and most reliable condition, as we include annual re-calibration on our state of the art calibration equipment. With the latest software releases and expert technical support, you will save time and money. We offer the following programs:

- Standard Service Agreement; Cleaning, Re-calibration, repair\*, firmware update(s) and warranty extension when serviced within 12 months subsequent intervals.
- Service Exchange Agreement; Annual exchange of your flow meter. No service time! Have a fully calibrated flow meter 24/7, 365 days a week!

\* *Repair within terms of usage, see general terms and conditions.*

The VPInstruments service subscriptions helps keeping you focused on what matters most for your company.

Benefits

- Annual calibrated and cleaned instruments
- Warranty extension
- Software- and firmware updates
- Personal (phone) support and e-mail support by our skilled technicians

Consult your distributor for the best VPInstruments service agreement for your business.

## 11 Specifications



**Please always check the label of your product for the specifications.**

Specifications are subject to change as we are continuously improving our products. Please contact us to obtain the latest specification sheet.

### Flow sensor

*(minimum detection level and max flow rate shown)*

- VPS.R080.M050	0.23 .. 80 m <sup>3</sup> <sub>n</sub> /hr	0.13 .. 50 SCFM
- VPS.R250.M100	0.91 .. 250 m <sup>3</sup> <sub>n</sub> /hr	0.54 .. 150 SCFM
- VPS.R01K.M200	3.55 .. 1000 m <sup>3</sup> <sub>n</sub> /hr	2.15 .. 600 SCFM

Accuracy	0.5% FSS under calibration conditions with tubing kit 5% FSS without tubing kit	
Reference conditions	0 °C, 1013.25 mbar - DIN1343	32 °F, 14.65 psi
Gas temperature	0 .. 60 °C	32 .. 140 °F
Gases	Compressed air, nitrogen, inert gases, 95% non condensing gases	

### Pressure sensor

Range	0 .. 16 bar gauge	0 .. 250 psi gauge
Accuracy	+/- 1.5% FSS (0 .. 60 °C)	+/- 1.5% FSS (32 .. 140 °F)

### Temperature sensor

Range	0 .. 60 °C	32 .. 140 °F
Accuracy	+/- 1 °C   1.8 °F (from 10 m <sub>n</sub> /sec   32 sfps and up) (At zero flow conditions, temperature reading increases due to self-heating by the flow sensor)	

### Display

Technology	Liquid crystal
Back light	Blue with auto power save
Memory	2 Million point memory option

### Mechanical

VPS.R080.M050	135 mm x 50 mm x 85 mm 0.7 Kg	5.31" x 1.97" x 3.35"	1.54 lbs
VPS.R250.M100	135 mm x 50 mm x 85 mm 0.7 Kg	5.31" x 1.97" x 3.35"	1.54 lbs
VPS.R01K.M200	155 mm x 90 mm x 125 mm 1.6 Kg	6.10" x 3.54" x 4.92"	3.58 lbs
IP grade	IP65 when mated to connector, at room temperature; direct rain and sunlight should be avoided. Extreme temperature fluctuations may affect the IP grade over time.		
Ambient temperature	0 .. 60 °C	32 .. 140 °F	
Wetted materials	Body: Anodized aluminum, Sensor: Silicon, epoxy, glass, Sealing: FTM 60, Polyurethane		

### Inputs and outputs

Analog	4 .. 20 mA or pulse, selectable via installation software
Serial IO	Modbus RTU USB for configuration (display version only)
Supply	12 .. 24 VDC +-10% CLASS 2 (UL)
Power consumption	150 mA at 24 VDC

### Certifications

CE	EN 61326-1(2006) Class A, EN 61000-6-1 (2007)
UL / CUL	14 AZ, Industrial Control Equipment

## 12 Order information and accessories

Order Code	Flow range	Option	Display	Option	Connector
VPS.R080.M050	0 .. 80 m <sup>3</sup> <sub>n</sub> /hr	D0	No display	C5	5 Pin M12
VPS.R250.M100	0 .. 250 m <sup>3</sup> <sub>n</sub> /hr	D10	Display	C8	8 Pin M12, for remote display*
VPS.R01K.M200	0 .. 1000 m <sup>3</sup> <sub>n</sub> /hr	D11	Display + 2M point logger		

\* The 8 Pin M12 connector can only be used in combination with a D0 model.

Basic features	Display features	Connector types
Thermabridge Flow sensor	3 row display	M12, 5 pin for standard application
Pressure, temperature sensor	Keypad for configuration	M12, 8 pin for remote display function
4 .. 20 mA / pulse output (switchable)	USB cable included	
RS485 Modbus RTU	Multi session data logger (option)	

VPA.0009.001	ISO Calibration report: 5 points, accuracy 0,5% full scale under calibration conditions with air
VPA.5000.911	Bi-directional measurement option
VPA.0001.093	Pressure upgrade to 35 bar   500 psi

### Tubing kits

VPA.1200.005	0.5 inch, in- and outlet tubes BSP
VPA.1200.105	0.5 inch, in- and outlet tubes NPT
VPA.1200.010	1 inch, in- and outlet tubes BSP
VPA.1200.110	1 inch, in- and outlet tubes NPT
VPA.1200.020	2 inch, in- and outlet tubes BSP
VPA.1200.120	2 inch, in- and outlet tubes NPT

### Accessories

VPA.5000.005	Cable, 5m / 16.4 ft with M12 5pin connector on one side, open wires on other side
VPA.5000.010	Cable, 10m / 32.9 ft with M12 5pin connector on one side, open wires on other side
VPA.0000.200	Power supply ( 12V, 5pin )
VPA.5003.000	RS485 to USB converter
VPA.5001.205	JB5 interface kit with 5m / 16.4ft cable + 12 VDC power supply + RS485 to USB converter



## 13 Appendix A - UL

The VPFlowScope complies with the CE requirements as stated in the CE declaration. CE compliance can only be achieved when grounding and shielding directions are followed and proper cables and connector assemblies are used.



### Electrical connection guidelines- UL 508 Listing for USA & Canada (Check label to see if product is UL marked)

The VPFlowScope is intended to be used with a Class 2 power source or Class 2 transformer in accordance with UL1310 or UL1585. As an alternative a LVLC (Low Voltage Limited Current) power source, with the following properties can be used:

- The device shall be used with a suitable isolating source such that the maximum open circuit voltage potential available to the product is not more than 24 VDC and the current is limited to a value not exceeding 8 amperes measured after 1 minute of operation;
- A fuse in accordance with the UL248 series and rated max 4A, shall be installed in the 24V DC power supply to the device? In order to limit the available current.

### Electrical connection guidelines: general remarks

Make sure that the following conditions are met:

- For portable, non-critical applications, a switched mode 12 VDC, 1A power adapter may be used. Switched mode power supplies that are of poor quality, might affect the accuracy.

Le VPFlowScope est conforme aux exigences CE, comme indiqué dans la déclaration CE. La conformité CE ne peut être atteinte que lorsque les directives de mise à la terre et d'isolation sont suivies et que les câbles et raccords appropriés sont utilisés.



### Lignes directrices pour branchements électriques – UL508 pour le Canada et les États-Unis (voir sur l'étiquette si le produit est marqué UL)

Le VPFlowscope est prévu pour être utilisé avec une source d'alimentation Classe 2 ou avec un transformateur de Classe 2 en accord avec UL1310 ou UL1585. Comme alternative, une source d'alimentation BTCL (Basse Tension Courant Limité) avec les propriétés suivante peut être utilisée :

- Le dispositif doit être utilisé avec une source d'isolation appropriée afin que le voltage maximal en circuit ouvert disponible pour le produit ne dépasse pas 24VDC, et que le courant soit limité à une valeur de 8 ampères après 1 minute de fonctionnement.
- Un fusible de 4A maximum, et conforme à la série UL248 doit être installé dans la source d'alimentation de l'appareil afin de limiter le courant disponible.

### Directives pour le raccordement électrique : remarques générales

Assurez-vous que les conditions suivantes sont remplies :

- Pour les applications mobiles, un adaptateur de type alimentation à découpage 12VDC, 1A peut-être utilisée. Cependant, un adaptateur de mauvaise qualité pourra affecter la précision.

## Notes

## Notes

energy insights trusted by professionals™

**VPInstruments**

Buitenwatersloot 335  
2614 GS Delft  
The Netherlands  
info@vpinstruments.com  
www.vpinstruments.com

MAN-VP-SINL-EN-2300

Date: 21-7-2023

